

CONVERTIBLE BENCH UNITS

 **HEAVY-DUTY**

 **VERSATILE**

 **COMPACT**





CONVERTIBLE BENCH IN USE



AUDITORIUM



1 BENCH with
3 SYSTEM
Configurations

TESTING



DINING



*Adaptable for your
Cafeteria, Auditorium
and Testing Center!*

Easy Set-up, Ganging, And Storage



Features



Create One Large Table By Combining Single Bench Units, Using the Built-in Ganging Devices.



Non-Marring Reinforced Nylon Glides With Steel Inserts Installed Over Leg Uprights.



"Pinch-Proof" Feature: Bench Does Not Touch the Top When Folding.



Under Table Hat Supports 1000 Lbs. Weight Capacity. (CBG96 Only)



4 Easy Lock 3" Double Ball-Bearing Heavy-Duty Casters.



Industrial-Grade 14-Gauge Square Tubing Legs and 16-Gauge Aprons.

Standard Lengths

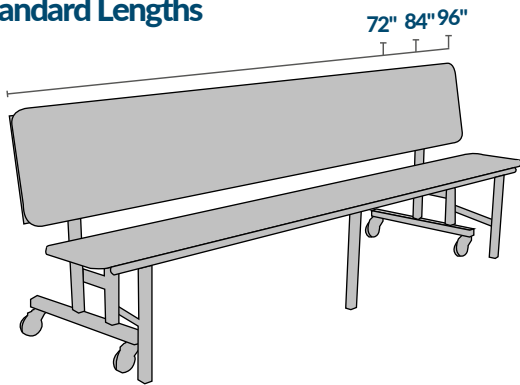

Model #	Seats	Table WxL	Folded Dimensions	Table-Seat Height (Standard)	Table-Seat Height (Custom)
CBG72	3-4	29"x72"	72"x12"x34"	29"-17"	25"-13"
CBG84	4-5	29"x84"	84"x12"x34"	29"-17"	27"-15"
CBG96	4-6	29"x96"	96"x12"x34"	29"-17"	32"-20"

Tabletops



[View our Laminate and Edge Design Options](#)

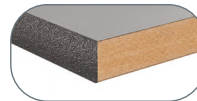

MDF with Protect Edge
.75" Core | HPL Surface
Protect Edge
(MD PE)

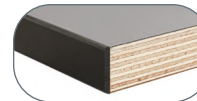

Plywood with 3mm PVC Edge
.75" Core | HPL Surface
3mm Hot-Melt PVC Edge
(PW EB)



Particleboard with T-Molding
.75" Core | HPL Surface
T-molding
(PB TM)

Bench/Table Heights

13"/25"
code: 25

15"/27"
code: 27

17"/29"
standard

20"/32"
code: 32

For non-standard heights add code to end of model number



24 HOUR QUICK SHIP

CBG96-MDPEPCGY (96"L, MDF Core, Black Protect Edge, Grey Nebula Back and Bench)



Model Number Configuration

Model Number | Core | Frame | Bench Laminate

CBG96 - PW PE PC CH GY

Edge | Back Laminate

Standard Edges *No minimum required*



Vinyl T-Molding | Black (TM)



Protect Edge | Black (PE)



3MM PVC Edge Banding | Black (EB)

Premium Edges *Subject to minimum quantity and upcharge*

VINYL T-MOLD



Beige (TB)



Green (TG)



Light Grey (TL)



Medium Grey (TE)



Navy (TN)



Red (TR)



Silver (TS)



Brown (TO)

PROTECT EDGE



Navy (PN)



Green (PG)



Red (PR)



Purple (PP)



Beige (PB)



Dark Grey (PD)



Medium Grey (PM)



Light Grey (PL)

3MM PVC
EDGE BANDING



Navy (EN)



Green (EG)



Red (ER)



Purple (EP)



Beige (EE)



Dark Grey (ED)



Medium Grey (EM)























Light Grey (EL)

Custom Logo Options

Upcharge and extended lead times apply



Standard Laminates *No minimum required*

						
Robin RN	Port PO	Regimental Red RR	Hollyberry RE	Candy Apple CD	Dragon Fire DF	Orange Grove OG
						
Maroochy Brush MB	Marigold YW	Sprout SU	Island IS	Hunter Green GR	Morrocan MA	Ocean OC
						
Persian Blue BL	Lapis Blue LB	Catalina CI	Indigo IN	Atlantis AT	Brittany Blue BB	Woolamai Brush WO
						
Navy Legacy NL	Concord Grape CG	Black BK	Graphite Nebula GN	Asian Night AN	Rustic Slate RS	Forged Steel FS
						
Figured Mahogany MY	Coffee Bean CB	Mantana Walnut WT	Windswept Bronze WZ	Pinnacle Walnut PN	Windsor Mahogany WM	Lowell Ash LA
						
Burnished Chestnut CT	Buka Bark KB	River Cherry RC	Nepal Teak NT	Wild Cherry CH	Fonthill Pear FP	Harvest Maple HM
						
New Age Oak NW	Monticello Maple MP	Bannister Oak OK	Castle Oak CO	Limber Maple LM	Kensington Maple KS	Fusion Maple FM
						
Manitoba Maple MT	Almond Leather AL	Tawny Legacy TL	Natural Almond NA	Desert Zephyr DZ	Natural Tigris NG	Natural Nebula NN
						
Steel Mesh SL	Slate Grey SG	Mystic Night MN	Pewter Brush PB	Windswept Pewter WP	Twilight Zephyr TZ	Boardwalk Oak BD

Standard Laminates

No minimum required



Premium Laminates

Subject to minimum quantity and upcharge



**IF YOU DON'T
SEE A LAMINATE,
JUST ASK!**

Choose any laminates from:

May be subject to minimum quantity and upcharge

