



ADA Compliant

This Space for Architect/Engineer Approval

Job Name _____ Date _____

Model Specified _____ Quantity _____

Customer/Wholesaler _____

Contractor _____

Architect/Engineer _____

5 7/16"
[138mm]

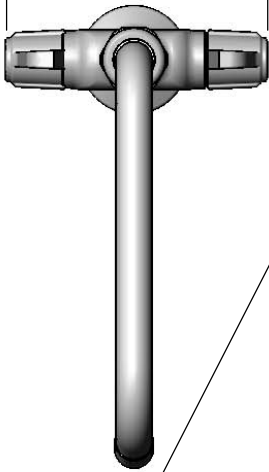

5SP-08A
8" Swing Nozzle
w/ 2.2 GPM Aerator.
Rigid Conversion Requires
014200-45 Lock Washer
(Sold Separately)

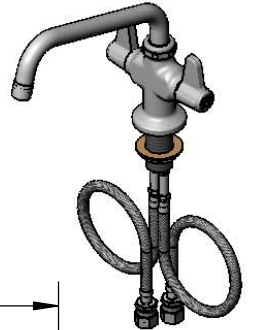

Quarter-Turn Ceramic
Cartridges & equip Lever
Handles w/ Color Coded
Screws

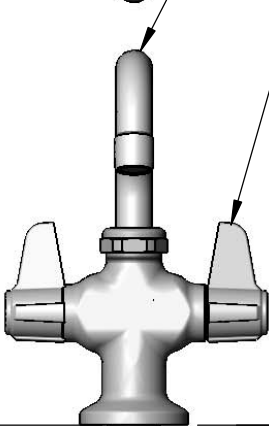

1 1/4"
[32mm]
Maximum
Thickness

7 13/16"
[199mm]

8 1/8"
[207mm]

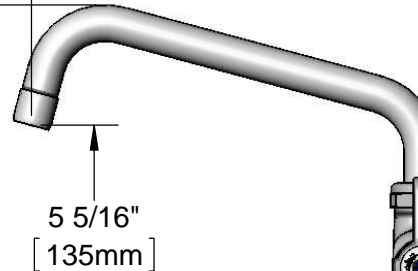

5 5/16"
[135mm]

Mounting Surface

Ø 2 1/4"
[57mm]

Ø 1 1/8"
[29mm]
Shank

18" Flexible
Stainless Steel
Supply Hose

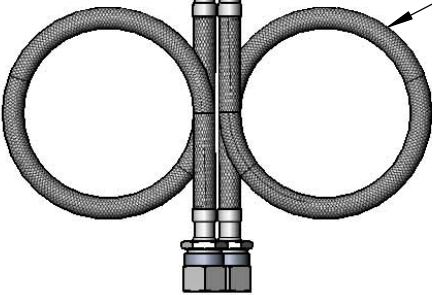

Compression Fittings for
5/8" O.D. Copper Tubing
(Remove Compression Nut
for 1/2" NPSM Male)

Rough-In Requirement
Ø 1 1/2" [38mm] Mounting Hole

Model Number

5F-2SLX08A

Product Specifications:

Single Hole Deck Mount Mixing Faucet, Quarter-Turn Ceramic Cartridges, equip Lever Handles, 8" equip Swing Nozzle, 2.2 GPM Aerator & 18" Flexible Inlets

Product Compliance:

ASME A112.18.1 / CSA B125.1
NSF 61 - Section 9
NSF 372 (Low Lead Content)
ANSI A117.1 (ADA)

equip
Foodservice
Accessories

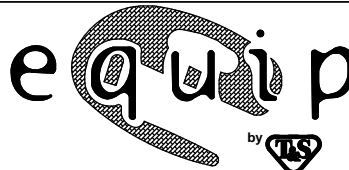

2 Saddleback Cove, P.O. Box 1088
Travelers Rest, South Carolina 29690
Phone: 800.891.4808 Fax: 800.868.0084
equip.tsbrass.com

Drawn: KJG

Checked: JRM

Approved: JHB

Date: 08/15/15

Scale: 1:4

Sheet: 1 of 2

ITEM NO.	SALES NO.	DESCRIPTION
1	013838-45	2.2 GPM Aerator, 3/4-27 UN Female
2	5SP-08A	8" equip Swing Nozzle
3	013839-25	equip Swivel Nut
4	013848-45	equip Swivel Piece O-Ring
5	013788-45	equip Quarter-Turn Ceramic Cartridge, LTC
6	5-HDL-L	equip Lever Handle w/ Color Coded Screws
7	002290-45	Lock Washer
8	000965-45	Lock Nut
9	012534-45	18" Flexible Supply Hose (2)
10	013787-45	equip Quarter-Turn Ceramic Cartridge, RTC

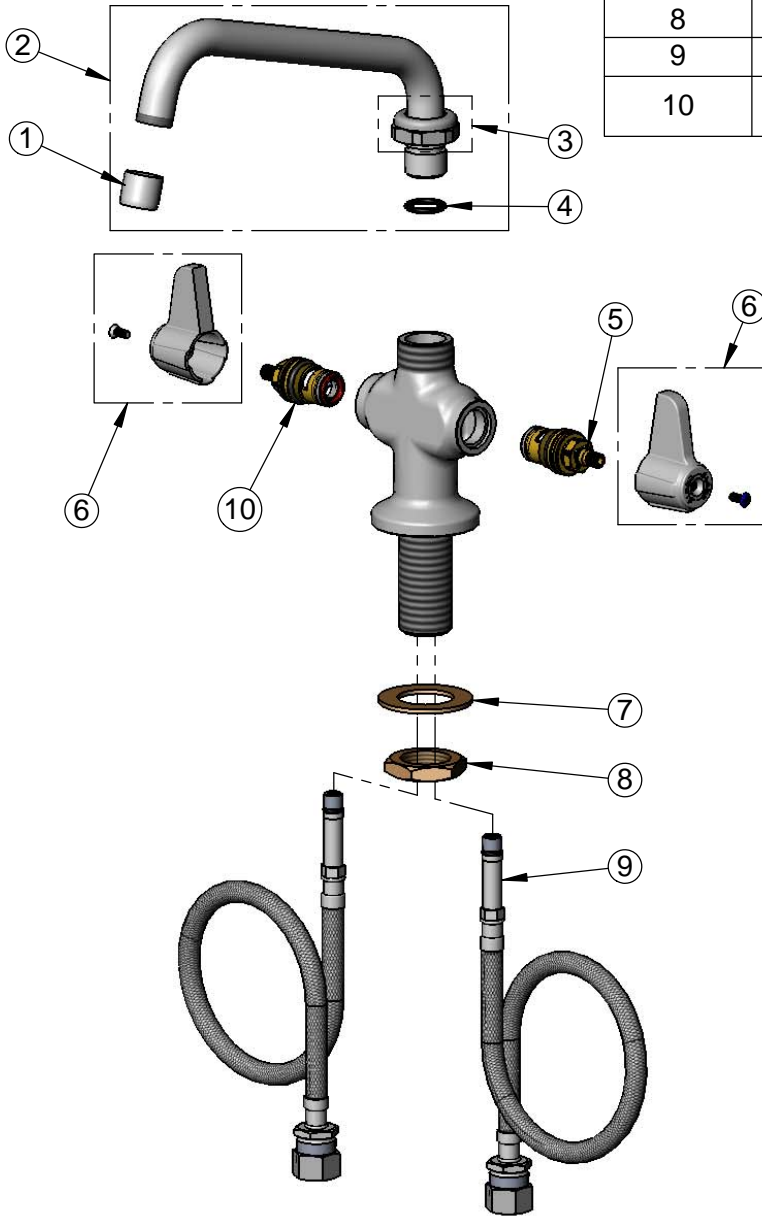

Model Number

5F-2SLX08A

Product Specifications:

Single Hole Deck Mount Mixing Faucet, Quarter-Turn Ceramic Cartridges, equip Lever Handles, 8" equip Swing Nozzle, 2.2 GPM Aerator & 18" Flexible Inlets

Product Compliance:

ASME A112.18.1 / CSA B125.1
NSF 61 - Section 9
NSF 372 (Low Lead Content)
ANSI A117.1 (ADA)

equip
Foodservice
Accessories



2 Saddleback Cove, P.O. Box 1088
Travelers Rest, South Carolina 29690
Phone: 800.891.4808 Fax: 800.868.0084
equip.tsbrass.com