



Project \_\_\_\_\_

Item # \_\_\_\_\_

Quantity \_\_\_\_\_

# Built-In Full-Size Insulated Heated Wells — UR, C-UR Fabricator Components

Models: HWBLIRT-FUL, -FULD,  
HWBLIBRT-FUL, -FULD,  
HWBIRT-FUL, -FULD,  
HWBIBRT-FUL, -FULD,  
HWBHIRT-FUL, -FULD,  
HWBHIBRT-FUL, -FULD

## With Square Corners

Models: HWBLIRTQ-FUL, -FULD,  
HWBLIBRTQ-FUL, -FULD,  
HWBIRTQ-FUL, -FULD,  
HWBIBRTQ-FUL, -FULD,  
HWBHIRTQ-FUL, -FULD,  
HWBHIBRTQ-FUL, -FULD

Hatco's Built-In Full-Size Insulated UR and C-UR Heated Wells are recognized as having UL components that hold hot food products at safe serving temperatures, plus have the added benefit of allowing fabricators the freedom to design their own steam tables.

## Standard features

- Rectangular Full-Size Insulated Heated Well in top or bottom mount
- Thermostatic or infinite controls available
- Without conduit and control box enclosure
- With or without drains
- 50% larger drain with flat screen simplifies cleaning and holds pans level
- Low (120V only), Standard and High Watt

\*Fabricator will need to obtain UL approvals.

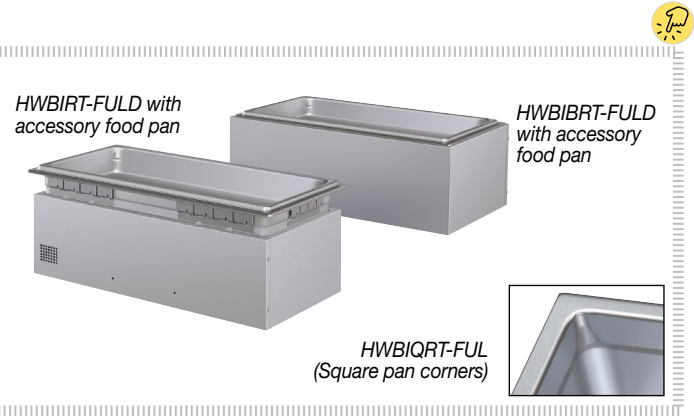

## Options (available at time of purchase only)

- Additional Power Supply Lead Wire available in 1' (305 mm) increments for "RN" (Infinite Control) Components (Lead Wire only - Conduit not included)
- Thermostat with 6' Capillary for RT Components (Thermostat only - Conduit not included)

## Accessories

Rectangular Full-Size Stainless Steel Food Pans:

- Third-Size (2.5" [64 mm] H)
- Half-Size (2.5" [64 mm] H)
- Full-Size (2.5" [64 mm] H)
- Full-Size (4" [101 mm] H)
- Full-Size (6" [152 mm] H)

Round Food Pans:

- 4-Quart (4-Liter)
- 7-Quart (7-Liter)

Hinged Lid for Round Pans:

- 4-Quart (4-Liter)
- 7-Quart (7-Liter)

Notched Lid for Round Pans:

- 4-Quart (4-Liter)
- 7-Quart (7-Liter)

Stainless Steel Wire Trivets:

- Half-Size
- Full-Size

Adapter to convert warmers to hold Round Pans

- Holds three 4-Quart (4-Liter) Inserts
- Holds two 7-Quart (7-Liter) Inserts

Support Bars:

- 12" (305 mm)
- 20" (508 mm)

Mounting Kit for:

- Combustible countertops
- Thicker countertops

- 3/4" Ball Valve for unit with Drains
- 3/4" Gate Valve for unit with Drains
- Heated Well Remote Handle for 3/4" Drains (requires a Ball or Gate Valve)



For operation, location and safety information, please refer to the Installation and Operating Manual.



HATCO CORPORATION | P.O. Box 340500 Milwaukee, WI 53234-0500 U.S.A. | (800) 558-0607 | (414) 671-6350



[www.hatcocorp.com](http://www.hatcocorp.com) | [support@hatcocorp.com](mailto:support@hatcocorp.com) | [Find a Hatco Rep](#) | [Image Library](#) | [Document Library](#) | [Chat](#)



# Built-In Full-Size Insulated Heated Wells — UR, C-UR Fabricator Components

Models: HWBLI-FUL, -FULD, HWBLIB-FUL, -FULD, HWBI-FUL, -FULD, HWBIB-FUL, -FULD, HWBHI-FUL, FULD, HWBHIB-FUL, -FULD

- "RT" added to model name indicates unit with thermostat control, lit rocker switch and 36" (914 mm) capillary (ex. HWBIRT-FUL)
- "RN" added to model name indicates unit with infinite switch control, pilot light and 36" (914 mm) lead (ex. HWBIRN-FUL)
- "Q" added to model name indicates unit with square corners (ex. HWBIRNQ-FUL)

## Ordering Instructions

(Please specify the following with each order)

1. **Desired Voltage:** 120, 208 or 240V  
(export voltage available)
2. **Base Size of Heated Well:**  
Rectangular: Full (12" x 20" [305 x 508 mm])
3. **Pan Corners**  
A. Rounded (Standard)  
B. Square
4. **Drain** (With or without)
5. **Mounting Style**  
A. Top Mounted  
B. Bottom Mounted
6. **Wattage**  
A. High Watt  
B. Standard Watt  
C. Low Watt (120V only)
7. **Agency:**  
A. UR and C-UR (UL recognized – conduit and control enclosures not included). Fabricators will need to obtain approvals

### HWBIRT-, HWBIQRT-FUL-UR Series (Top Mount)

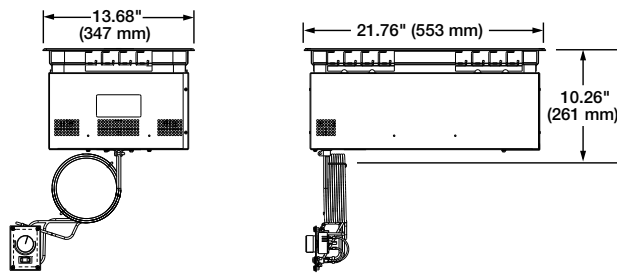

### HWBIBRT-, HWBIBQRT-FUL-UR Series (Bottom Mount)

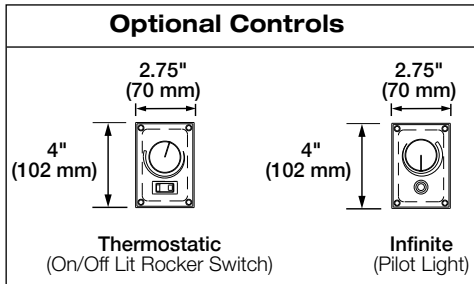
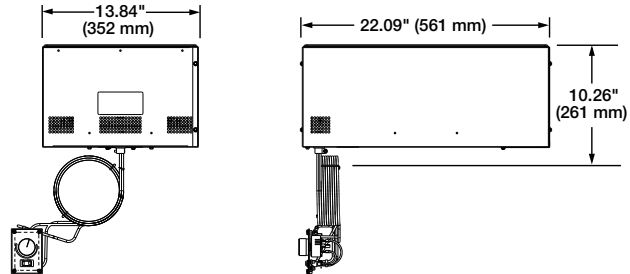

### Cutout Dimensions for Non-Combustible Countertops

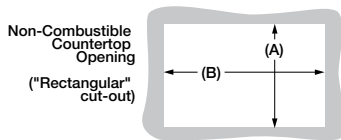

Model	Minimum Width (A)	Maximum Width (A)	Minimum Depth (B)	Maximum Depth (B)
HWBIRT-, HWBIRN-FUL, -FULD Series HWBIBRTQ-, HWBIBRNQ-FUL, -FULD Series	12.75" (324 mm)	12.94" (328 mm)	20.75" (528 mm)	20.94" (531 mm)
HWBIBRT-, HWBIBRN-FUL, -FULD Series <sup>▼</sup> HWBIBRTQ-, HWBIBRNQ-FUL, -FULD Series <sup>▼</sup>	12.03" (306 mm)	12.03" (306 mm)	20.03" (509 mm)	20.03" (509 mm)

<sup>▼</sup> Must be flanged.

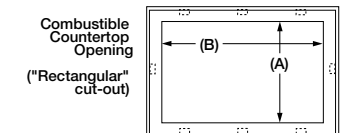

### Cutout Dimensions for Combustible Countertops<sup>▲</sup>

Model	Minimum Width (A)	Maximum Width (A)	Minimum Depth (B)	Maximum Depth (B)
HWBIRT-, HWBIRN-FUL, -FULD Series HWBIBRTQ-, HWBIBRNQ-FUL, -FULD Series	14" (356 mm)	14.25" (362 mm)	22" (559 mm)	22.25" (565 mm)

<sup>▲</sup> Accessory Mounting Kit required for Top Mounts

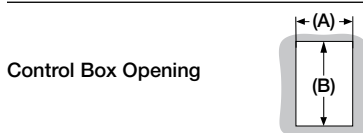

### Cutout Dimensions for Control Boxes

Control Box	Width (A)	Height (B)
T-Stat Control	2.125" (54 mm)	3.375" (86 mm)
Infinite Control	2.125" (54 mm)	3.375" (86 mm)

HATCO CORPORATION | P.O. Box 340500 Milwaukee, WI 53234-0500 U.S.A. | (800) 558-0607 | (414) 671-6350

[www.hatcocorp.com](http://www.hatcocorp.com) | [support@hatcocorp.com](mailto:support@hatcocorp.com) | [Find a Hatco Rep](#) | [Image Library](#) | [Document Library](#) | [Chat](#)



# Built-In Full-Size Insulated Heated Wells — UR, C-UR Fabricator Components

Models\*: HWBLI-FUL, -FULD, HWBLIB-FUL, -FULD, HWBI-FUL, -FULD, HWBIB-FUL, -FULD, HWBHI-FUL, FULD, HWBHIB-FUL, -FULD

- \* "RT" added to model name indicates unit with thermostat control, lit rocker switch and 36" (914 mm) capillary (ex. HWBIRT-FUL)
- "RN" added to model name indicates unit with infinite switch control, pilot light and 36" (914 mm) lead (ex. HWBIRN-FUL)
- "Q" added to model name indicates unit with square corners (ex. HWBIRNQ-FUL)

## Full-Size Rectangular Insulated Models — UR, C-UR Fabricator Components

The shaded areas contain electrical information for International models only

	Model*	Dimensions (Width x Depth x Height)	Volts* (Single Phase)	Watts	Amps	Ship Weight
Low Watt	HWBLIRT-, HWBLIRTQ -FUL HWBLIRT-, HWBLIRTQ-FULD (Top or Bottom Mount)	13.68" x 21.76" x 10.26" (347 x 553 x 261 mm)	120	750	6.3	27 lbs. (12 kg) 19 lbs. (9 kg)
	HWBLIBRT-, HWBLIBRTQ-FUL HWBLIBRT-, HWBLIBRTQ-FULD (Bottom Mount only)	13.84" x 22.09" x 10.26" (352 x 561 x 261 mm)				28 lbs. (12 kg) 26 lbs. (12 kg)
Standard Watt	HWBIRT-, HWBIRTQ-FUL HWBIRT-, HWBIRTQ-FULD (Top or Bottom Mount)	13.68" x 21.76" x 10.26" (347 x 553 x 261 mm)	120	1200	10.0	24 lbs. (11 kg) 26 lbs. (12 kg)
			208			
			240			
			220			
	HWBIBRT-, HWBIBRTQ-FUL HWBIBRT-, HWBIBRTQ-FULD (Bottom Mount only)	13.84" x 22.09" x 10.26" (352 x 561 x 261 mm)	120	1200	10.0	27 lbs. (12 kg) 26 lbs. (12 kg)
			208			
			240			
			220			
High Watt	HWBHIRT-, HWBHIRTQ-FUL HWBHIRT-, HWBHIRTQ-FULD (Top or Bottom Mount)	13.68" x 21.76" x 10.26" (347 x 553 x 261 mm)	120	1650	13.8	26 lbs. (12 kg) 28 lbs. (13 kg)
			208			
			240			
			220			
			240			
	HWBHIBRT-, HWBHIBRTQ-FUL HWBHIBRT-, HWBHIBRTQ-FULD (Bottom Mount only)	13.84" x 22.09" x 10.26" (352 x 561 x 261 mm)	120	1650	13.8	29 lbs. (13 kg) 28 lbs. (13 kg)
			208			
			240			
			220			
			240			

- \* "RT" added to model name indicates unit with thermostat control, lit rocker switch and 36" (914 mm) capillary.
- "RN" added to model name indicates unit with infinite switch control, pilot light and 36" (914 mm) leads.
- CE Mark not available.

### PRODUCT SPECS Built-In Full-Size Insulated Heated Wells

The Built-In Rectangular Insulated Heated Well – UR, C-UR Fabricator Components with rounded or square corners shall be a Model...as manufactured by the Hatco Corporation, Milwaukee, WI 53234 U.S.A.

The Built-In Insulated Heated Well shall be rated at ...watts, ...volts, and be ...inches (millimeters) in overall width and be ...inches (millimeters) in overall depth. It shall consist of stainless and aluminized steel housing with a metal sheathed

heating element, EZ locking hardware for installation, and a remote thermostat with lighted power switch. Models with a drain consist of a 3/4" NPT drain.

Warranty consists of 24/7 parts and service assistance (US and Canada only).

HATCO CORPORATION | P.O. Box 340500 Milwaukee, WI 53234-0500 U.S.A. | (800) 558-0607 | (414) 671-6350

[www.hatcocorp.com](http://www.hatcocorp.com) | [support@hatcocorp.com](mailto:support@hatcocorp.com) | [Find a Hatco Rep](#) | [Image Library](#) | [Document Library](#) | [Chat](#)