

BASE MODEL SANDWICH UNIT

Model: RA68N12M

Natural Refrigerant R-290 Model

68" Mighty Top Sandwich Unit Refrigerator with Solid Doors - 12 Pans

Heavy gauge #300 series stainless steel top, stainless steel front and end panels, galvanized steel rear and grills and aluminum interior.



Options and Accessories

(upcharge and lead times may apply)

Stainless steel interior	Flat lid
Stainless steel back	Vision panel lid
Additional epoxy coated steel shelves	Door locks
Stainless steel shelves	Front breathing
Overshelves (single or double)	Rear mounted cutting board
Adjustable legs	Composite cutting board
Pan slides	Compressor left (standard on right)
Drawers in lieu of doors**	

Drawer in lieu of door section above the condensing unit*

Consult factory for other model configurations, options and accessories.

*Drawer section above condensing unit holds (1) 12 x 20 x 6 pan.

**Two tier (larger section) holds:

TOP DRAWER: (1) 12 x 20 x 6 AND (3) 1/6 x 6 pans

BOTTOM DRAWER: (2) 12 x 20 x 6 pans

Continental
Refrigerator



Project Name:

Model Specified:

Location:

Item No:

Quantity:

AIA #:

SIS #:

Standard Model Features

REFRIGERATION SYSTEM

Performance rated refrigeration system

Natural, environmentally safe, high efficiency R-290 refrigerant¹

Unique forced air design utilizes fans (approx. every 12") across the entire back of unit for even distribution of cold

Automatic, hot gas condensate evaporator

Non-corrosive, plasticized fin evaporator coil

Easily serviceable, slide out condensing unit

Expansion valve system

CABINET ARCHITECTURE

2" non-CFC polyurethane foam insulation

Smooth, polished chrome door handles

Spring loaded, self closing doors

Magnetic snap in Santoprene™ door gaskets

Heavy duty, epoxy coated steel shelves

10" deep, full length nylon cutting board

Insulated lid

5" casters

MODEL FEATURES

Refrigerated section with door above the condensing unit

(12) 1/6 size recessed pans, 4" deep

Electronic control, off-cycle defrost

Field rehingeable doors

¹ R-290 refrigerant meets all federal and state regulatory requirements.

NOTE: Models come standard with a door above the condensing unit. A drawer above the condensing unit is an option.

APPROVAL:

Model Specifications

DIMENSIONAL DATA

Net Capacity (cubic feet)	22 (623 cu l)
1/6 Size Pans (4" deep)	12
Width, Overall (inches)	68 (1727 mm)
Depth, Overall (inches) (including handles & bumpers)	37 (940 mm)
Depth, Cutting Board (inches)	10 (254 mm)
Height, Overall (inches) (including 5" casters)	42 (1067 mm)
Shelf Area (square feet)	9.8 (0.9 sq m)
Number of Shelves	4
Number of Full Doors	2
Number of Half Doors	1
Interior Depth (inches)	30 (762 mm)
Interior Height (inches)	26 (660 mm)
Interior Height (inches) (above condenser)	12 1/2 (318 mm)
Interior Width (inches)	64 (1626 mm)

REFRIGERANT DATA

Condensing Unit Size (H.P.)	1/3+
Capacity (BTU per hour)*	2600

ELECTRICAL DATA

Voltage (International)	115/60/1 (220/50/1)
Total Amps (International)	5.8 (3.9)
10 ft. Cord/Plug [attached] (International)	Yes (No)

SHIPPING DATA

Weight (pounds)	490 (222 kg)
Height - Crated (inches)	43 3/4 (1111 mm)
Width - Crated (inches)	70 (1778 mm)
Depth - Crated (inches)	47 (1194 mm)

* Rating @ +25°F evaporator, 90°F ambient
Figures in parentheses reflect metric equivalents rounded to the nearest whole unit.



Equipped with one NEMA-5-15P Plug
(varies by country)

Continental[®]

Refrigerator

Toll-Free: 800-523-7138
Phone: 215-244-1400
Fax: 215-244-9579

539 Dunksferry Road
Bensalem, PA 19020
www.continentalrefrigerator.com

Due to our continued efforts in developing innovative products, specifications subject to change without notice.



PROUDLY
DESIGNED & ASSEMBLED
IN THE U.S.A.

© Copyright 2021. Continental Refrigerator.
A Division of National Refrigeration & Air Conditioning Products, Inc.

Model Plan Views

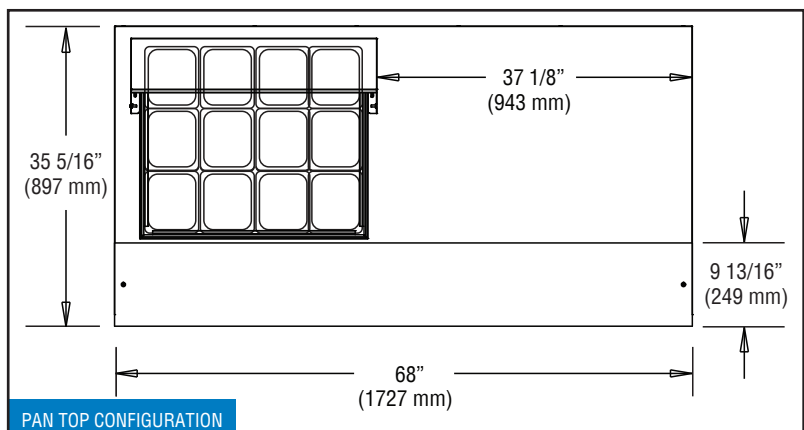
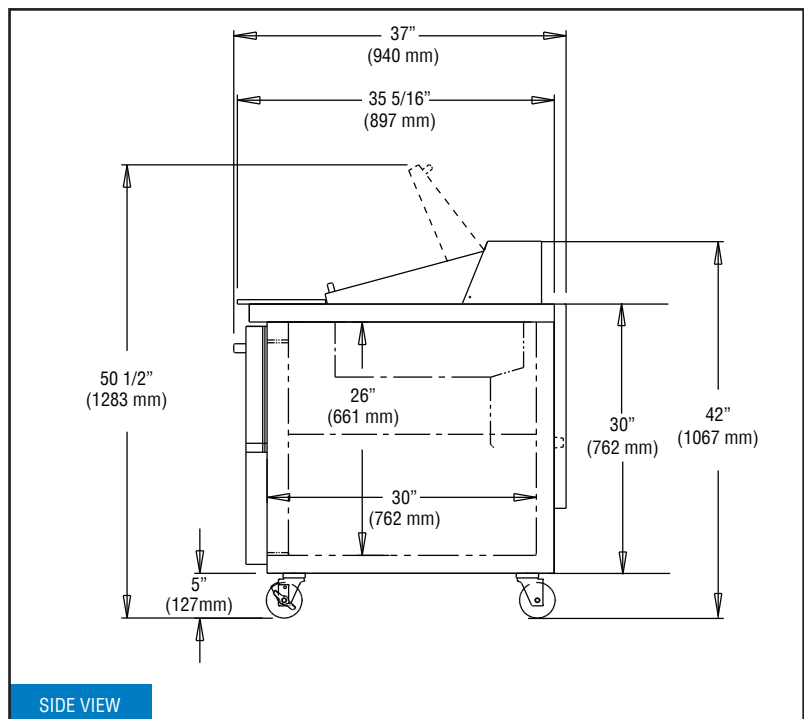
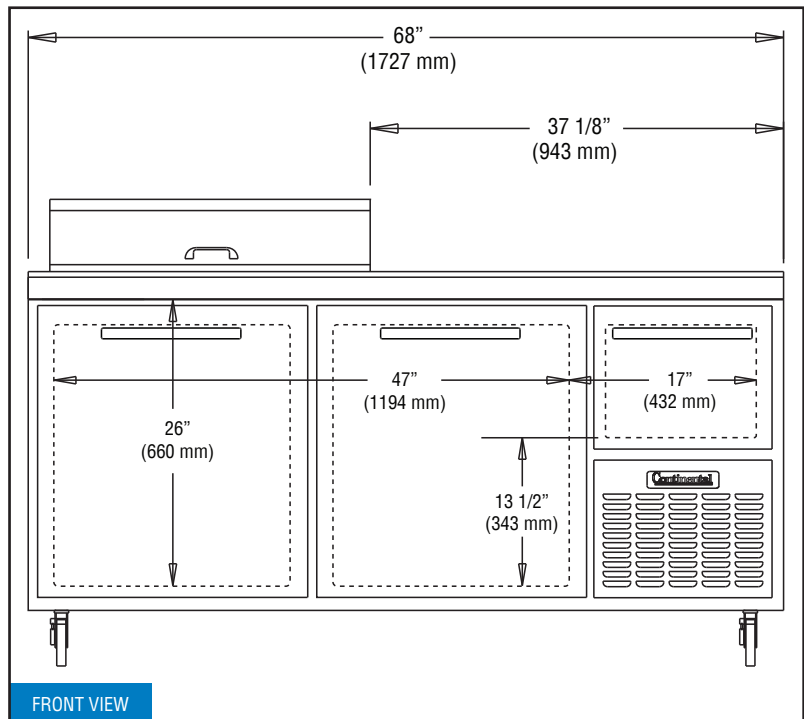

REVISED: 3/8/24