



Project _____

Item # _____

Quantity _____

Drop-In Round Heated Wells — UR, C-UR Fabricator Components

Models:

- HWBRT-4QT, -4QTD, -7QT, -7QTD, -11QT, -11QTD
- HWBRN-4QT, -4QTD, -7QT, -7QTD, -11QT, -11QTD
- HWBHRT-7QT, -7QTD, -11QT, -11QTD
- HWBHRN-7QT, -7QTD, -11QT, -11QTD

Hatco's Drop-In Round Heated Wells are ideal for the fabricator who wants to design a specific steam table layout. Easy to install, and easy to service, comes with control, size, drain, voltage and wattage choices. The rugged, quality construction ensures that Hatco Heated Wells will last through the rigors of commercial use.

Standard features

- Available in 4-, 7- and 11-quart (4-, 7- and 10-liter) Drop-In Round Wells
- Thermostatic controls feature a separate lighted ON/OFF switch and temperature dial, allowing preset temperatures to be maintained
- Thermostatic or infinite controls available
- Without conduit and control box enclosure
- With or without drain
- Standard or High Watt (4-quart [4-liter] standard watt only)
- Mounting kits for combustible countertops available
- EZ locking hardware for quick installation

*Fabricator will need to obtain UL or other approvals.

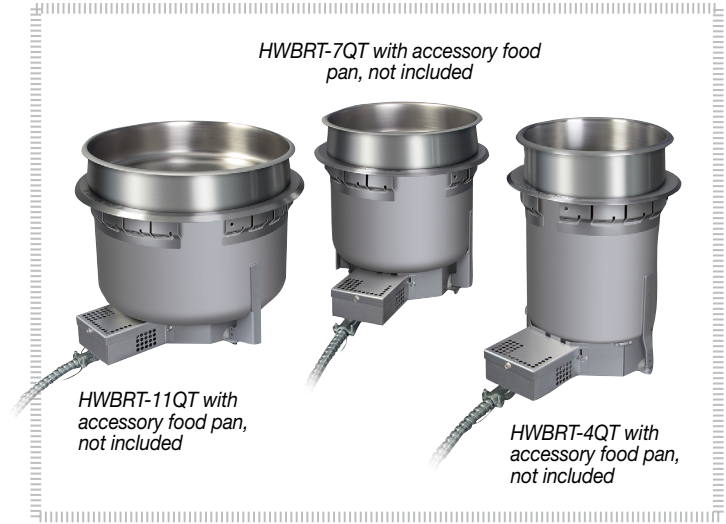

Options (available at time of purchase only)

- Additional Power Supply Lead Wire in 1' (305 mm) increments for "RN" (Infinite Control) Components (Lead Wire only)
- Thermostat with 6' Capillary for "RT" components (Thermostat only - Conduit not included)

Accessories

- Round Pans
 - 4-Quart (4-Liter)
 - 7-Quart (7-Liter)
 - 11-Quart (10-Liter)
- Notched Lids
 - 4-Quart (4-Liter)
 - 7-Quart (7-Liter)
 - 11-Quart (10-Liter)
- Hinged Lids
 - 4-Quart (4-Liter)
 - 7-Quart (7-Liter)
 - 11-Quart (10-Liter)

Mounting Kit for:

- Combustible countertops
- Thicker countertops
- 3/4" Ball Valve for unit with Drains
- 3/4" Gate Valve for unit with Drains
- Heated Well Remote Handle for 3/4" Drains (requires a Ball or Gate Valve)



For operation, location and safety information, please refer to the Installation and Operating Manual.



HATCO CORPORATION | P.O. Box 340500 Milwaukee, WI 53234-0500 U.S.A. | (800) 558-0607 | (414) 671-6350



www.hatcocorp.com | support@hatcocorp.com | [Find a Hatco Rep](#) | [Image Library](#) | [Document Library](#) | [Patents](#) | [Chat](#)



Drop-In Round Heated Wells — UR, C-UR Fabricator Components

Models: ■ HWB-4QT, -4QTD, -7QT, -7QTD, -11QT, -11QTD, HWBH-7QT, -7QTD, -11QT, -11QTD
 ■ "RT" added to model name indicates unit with thermostat control, lit rocker switch and 36" (914 mm) capillary (ex. HWBRT-4QT).
 ■ "RN" added to model name indicates unit with infinite switch control, pilot light and 36" (914 mm) lead (ex. HWBRN-4QT).

Ordering Instructions

(Please specify the following with each order)

1. **Desired Voltage:** 120, 208 or 240V
(export voltage available)
2. **Base Size of Heated Well:**
 - A. 4-Quart (4-Liter), 7-Quart (7-Liter) or 11-Quart (10-Liter)
3. **Drain** (With or without)
4. **Mounting Style** (Top Mounted)
 - A. Non-Combustible Countertop
 - B. Combustible Countertop requires accessory Mounting Kit
5. **Wattage:**
 - A. High Watt
 - B. Standard Watt (4-Quart [4-Liter] available in standard watt only)
6. **Agency:**
 - A. UR and C-UR (UL recognized – Conduit and control enclosures not included). Fabricators will need to obtain approvals

Models HWB-4QT, HWB-7QT and HWB-11QT Series

(HWB-7QTD Shown)

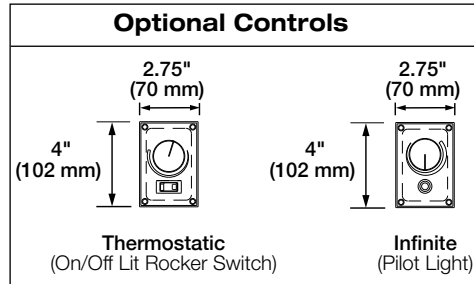
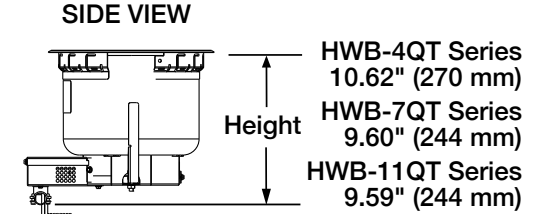
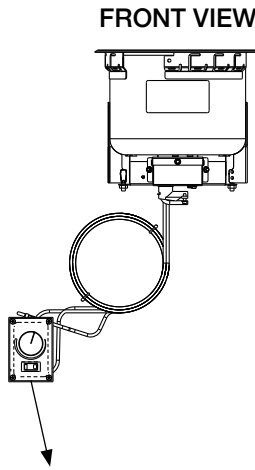
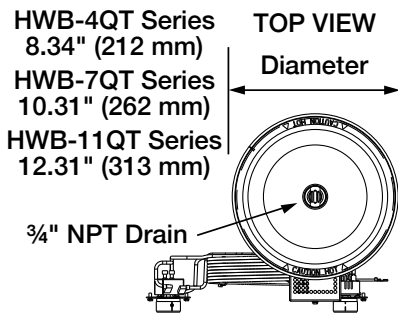

Non-Combustible
Countertop
Opening

("Circular" cut-out)

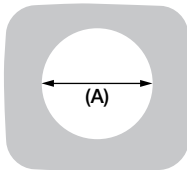

Cutout Dimensions for Non-Combustible Countertop

Model	Minimum Diameter (A)	Maximum Diameter (A)
HWB-4QT	Ø 7.125" (181 mm)	Ø 7.56" (192 mm)
HWB-7QT	Ø 9.125" (232 mm)	Ø 9.56" (242 mm)
HWB-11QT	Ø 11.125" (283 mm)	Ø 11.56" (293 mm)

Combustible
Countertop
Opening

("Square" cut-out)

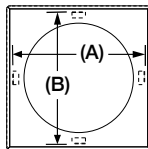

Cutout Dimensions for Combustible Countertops ▲

Model	Minimum Width (A)	Maximum Width (A)	Minimum Depth (B)	Maximum Depth (B)
HWB-4QT	9" (229 mm)	9.25" (235 mm)	9" (229 mm)	9.25" (235 mm)
HWB-7QT	11" (279 mm)	11.25" (286 mm)	11" (279 mm)	11.25" (286 mm)
HWB-11QT	13" (330 mm)	13.25" (337 mm)	13" (330 mm)	13.25" (337 mm)

▲ Accessory Mounting Kit required

HATCO CORPORATION | P.O. Box 340500 Milwaukee, WI 53234-0500 U.S.A. | (800) 558-0607 | (414) 671-6350



www.hatcocorp.com | support@hatcocorp.com | [Find a Hatco Rep](#) | [Image Library](#) | [Document Library](#) | [Patents](#) | [Chat](#)



Drop-In Round Heated Wells — UR, C-UR Fabricator Components

Models: ■ HWB-4QT, -4QTD, -7QT, -7QTD, -11QT, -11QTD, HWBH-7QT, -7QTD, -11QT, -11QTD
 ■ "RT" added to model name indicates unit with thermostat control, lit rocker switch and 36" (914 mm) capillary (ex. HWBRT-4QT).
 ■ "RN" added to model name indicates unit with infinite switch control, pilot light and 36" (914 mm) lead (ex. HWBRN-4QT).

Control Box Opening

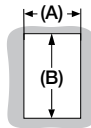

Cutout Dimensions for Control Boxes

Control Box	Width (A)	Height (B)
T-Stat Control	2.125" (54 mm)	3.375" (86 mm)
Infinite Control	2.125" (54 mm)	3.375" (86 mm)

Drop-In Round UR Wells — UR, C-UR Fabricator Components

■ The shaded areas contain electrical information for International models only

	Model [■] (Top Mount Only)	Dimensions (Diameter x Height)	Volts [*]	Phase	Watts	Amps	Optional Control Configuration	Ship Weight	
Standard Watt	HWBRT-4QT HWBRT-4QTD HWBRN-4QT HWBRN-4QTD	8.34" x 10.62" (212 x 270 mm)	120	Single	500	4.2	Thermostatic (ON/OFF lit rocker switch)	9 lbs. (4 kg) 9 lbs. (4 kg) 6 lbs. (3 kg) 10 lbs. (5 kg)	
			208		536	2.6			
			240		600	2.5			
			220-230 (CE)		600	2.7			
			220		600	2.7			
			230-240 (CE)		600	2.5			
240	600	2.5							
Standard Watt	HWBRT-7QT HWBRT-7QTD HWBRN-7QT HWBRN-7QTD	10.31" x 9.60" (262 x 244 mm)	120	Single	500	4.2		Thermostatic (ON/OFF lit rocker switch)	11 lbs. (5 kg) 11 lbs. (5 kg) 7 lbs. (3 kg) 10 lbs. (5 kg)
			208		536	2.6			
			240		600	2.5			
			220		600	2.7			
			240		600	2.5			
			240		600	2.5			
Standard Watt	HWBRT-11QT HWBRT-11QTD HWBRN-11QT HWBRN-11QTD	12.31" x 9.59" (313 x 244 mm)	120	Single	500	4.2	Thermostatic (ON/OFF lit rocker switch)		10 lbs. (5 kg) 11 lbs. (5 kg) 10 lbs. (5 kg) 11 lbs. (5 kg)
			208		536	2.6			
			240		600	2.5			
			220		600	2.7			
			240		600	2.5			
			240		600	2.5			
High Watt	HWBHRT-7QT HWBHRT-7QTD HWBHRN-7QT HWBHRN-7QTD	10.31" x 9.60" (262 x 244 mm)	120	Single	800	6.7		Thermostatic (ON/OFF lit rocker switch)	11 lbs. (5 kg) 9 lbs. (4 kg) 7 lbs. (3 kg) 13 lbs. (6 kg)
			208		715	3.4			
			240		800	3.3			
			220		800	3.6			
			240		800	3.3			
			240		800	3.3			
High Watt	HWBHRT-11QT HWBHRT-11QTD HWBHRN-11QT HWBHRN-11QTD	12.31" x 9.59" (313 x 244 mm)	120	Single	800	6.7	Thermostatic (ON/OFF lit rocker switch)		15 lbs. (7 kg) 11 lbs. (5 kg) 10 lbs. (5 kg) 13 lbs. (6 kg)
			208		715	3.4			
			240		800	3.3			
			220		800	3.6			
			240		800	3.3			
			240		800	3.3			

■ "RT" added to model name indicates unit with thermostat control, lit rocker switch and 36" (914 mm) or 72" (1829 mm) capillary.

"RN" added to model name indicates unit with infinite switch control, pilot light and 36" (914 mm) leads. Additional lengths available in one foot (305 mm) increments.

• CE Mark not available.

PRODUCT SPECS

Drop-In Round Heated Wells

The Drop-In Round Heated Well — UR, C-UR Fabricator Components shall be a Model ...as manufactured by the Hatco Corporation, Milwaukee, WI 53234 U.S.A. The Drop-In Heated Well shall be rated at ...watts, ...volts, and be ...inches (millimeters) in overall width and be ...inches (millimeters) in overall depth. It shall consist of stainless and aluminized steel housing with a metal sheathed heating element, EZ locking hardware for installation, and a remote switch. Models with a drain consist of a 3/4" NPT drain.

Warranty consists of 24/7 parts and service assistance (US and Canada only).

HATCO CORPORATION | P.O. Box 340500 Milwaukee, WI 53234-0500 U.S.A. | (800) 558-0607 | (414) 671-6350



www.hatcocorp.com | support@hatcocorp.com | [Find a Hatco Rep](#) | [Image Library](#) | [Document Library](#) | [Patents](#) | [Chat](#)