

CIR-24/24



Intertek
 4004503
 Conforms to ANSI/NSF STD 2

Specifications

Drain

- 1/2" welded tailpiece drain

Materials

- 20 gauge stainless steel

Project: _____	AIA# _____
Item #: _____ Qty: _____	SIS# _____
Model #: _____	

Corner Inside Rectangle Drainboards

CIR

CIR-19/19, CIR-19/19-N, CIR-19/24L, CIR-19/24R, CIR-19/30L, CIR-19/30R, CIR-24/24, CIR-24/24-N, CIR-24/24-LN, CIR-24/30L, CIR-24/30R

Standard Features

- All stainless steel
- Designed to mount between two adjacent pieces of Glastender underbar equipment (unless optional legs are used, see configurable options)
- Drain pan with separate perforated insert for better air circulation
- 1/4" radius work surface corners for easy cleaning

Configurable Options

- Leg set for one side mounting
- Leg set for freestanding (CIR-24/24-LN excluded)

To view underbar installation instructions, please visit:

https://www.glastender.com/PDF/F-750-165_Underbar_Installation_Instructions.pdf

To view cleaning and care instructions, please visit: https://www.glastender.com/PDF/F-423-011_ss_clean_care.pdf

Glastender, Inc. • 5400 N Michigan Rd • Saginaw, MI • 48604-9780
 989.752.4275 • 800.748.0423 • Fax 989.752.4444
www.glastender.com

Approval/Notes:

Specifications subject to change without notice. For current specifications please visit our website.

Corner Inside Rectangle Drainboards

Drawings

PLAN VIEWS

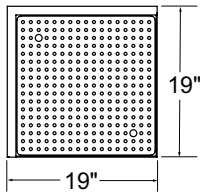

CIR-19/19

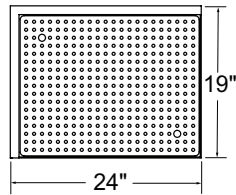

CIR-19/24L

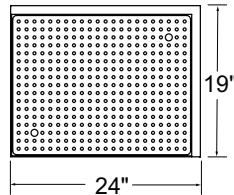

CIR-19/24R

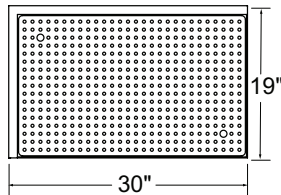

CIR-19/30L

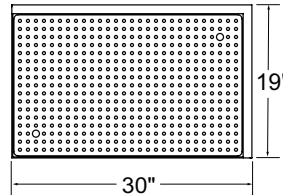

CIR-19/30R

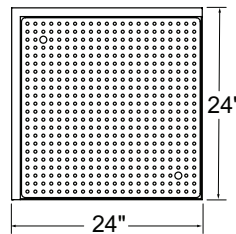

CIR-24/24

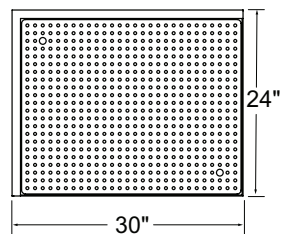

CIR-24/30L

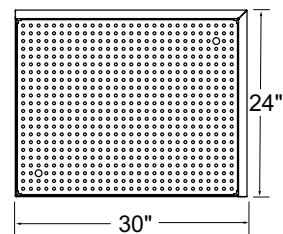

CIR-24/30R

PLAN VIEWS

DIMENSIONAL CORNER DRAINBOARDS WITH CHAMFERED BACK CORNER VIEWS

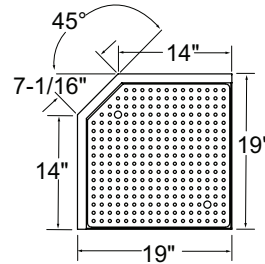

CIR-19/19-N

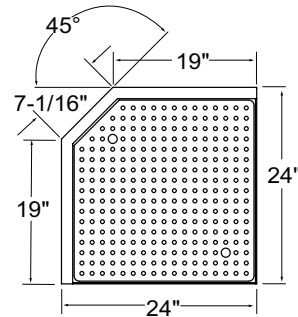

CIR-24/24-N

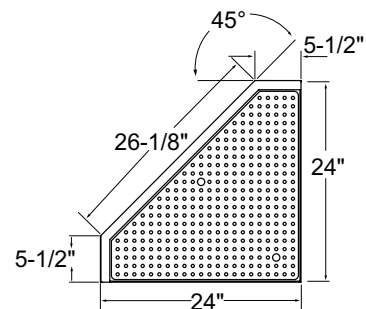

CIR-24/24-LN