

WARING COMMERCIAL

MX1200XT

64 oz. BPA-Free copolyester container

MX1200XTP

32-48 oz. BPA-Free copolyester container

MX1200XTS

64 oz. stainless steel container

Unit Information

Limited 3 Year Motor Warranty
Two Year Parts & Labor
60Hz - 13 Amps
Height 19" - Weight 15 lbs.
3 HP Motor
RPM's Variable 1,500-20,000
Pulse 30,000
One Piece Dishwasher Safe
Removable Jar Pad

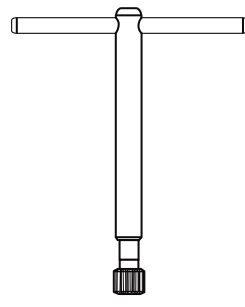
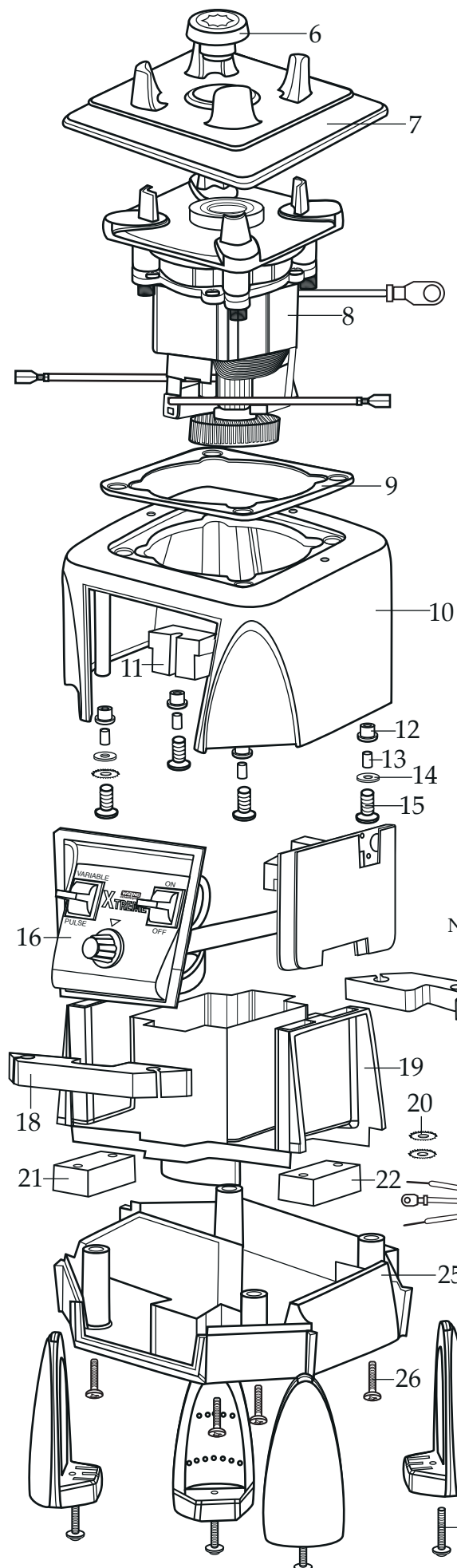

503351
MX Coupling Wrench
(optional)

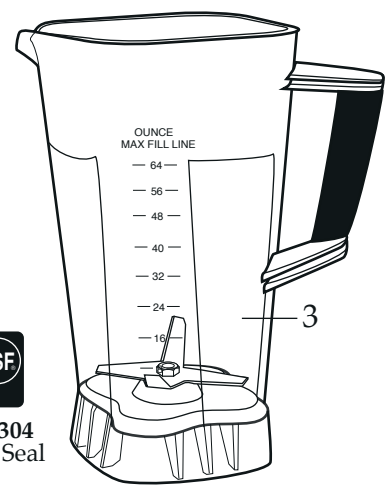
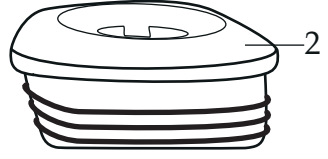
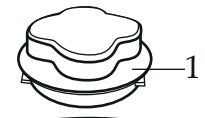

013304
NSF Seal

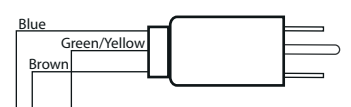
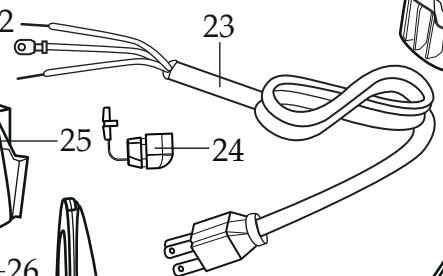
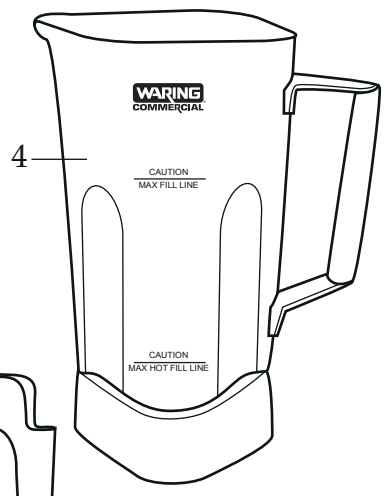

Wiring Diagram

Catalog	Model
MX1200XT	MX1200XT11
MX1200XTP	MX1200XT21
MX1200XTS	MX1200XT31



Illustration #	Part #	Description
1	026425-E	Jar Lid Cover
2	026424	Jar Lid
3	503347	Jar with Blending Assy. /64 oz. Eastman
4	503346	Jar with Blending Assy. /64 oz. stainless steel
5	503348	Jar with Blending Assy. /32-48 oz. Eastman
6	028538	Drive Clutch
7	026442	Jar Pad
8	028101	Motor
9	026437	Dampening Plate Gasket
10	028032-09	Top Housing /black
11	028541	Motor Foam 2 Req.'d
12	026439	Dampening Plate Bushing 4 Req.'d
13	026453	Dampening Plate Sleeve 4 Req.'d
14	026459	Washer 2 Req.'d
15	028929	Screw 4 Req.'d
	026459	Washer 4 Req.'d <i>(older units)</i>
	026455	Screw 4 Req.'d <i>(older units)</i>
16	029811	Soft Start Control Panel
	028268	Control Panel <i>(older units)</i>
17	028248	Housing Foam Baffle /rear
18	028249	Housing Foam Baffle /front
19	028240	Motor Housing
20	002943	Washer 3 Req.'d
21	028247	Bottom Housing Foam Baffle
22	028542	Foam Baffle
23	026925	Cord Set
24	007556	Strain Relief
25	028241-09-x	Bottom Housing /black
26	012505	Screw 4 Req.'d
27	026430	Corner Post 4 Req.'d
28	028928	Screw 4 Req.'d
	026459	Washer 4 Req.'d <i>(older units)</i>
	012505	Screw 4 Req.'d <i>(older units)</i>

Catalog	Model
MX1200XT	MX1200XT11
MX1200XTP	MX1200XT21
MX1200XTS	MX1200XT31

Waring Factory Service Center
 314 Ella T. Grasso Ave.
 Torrington, CT 06790
 Tele. 1-800-269-6640
 Fax 860-496-9017
 www.waringproducts.com

Illustration #	Part #	Description
29	503345	Blade Assy.
30	024271	O Ring
31	024268	Nut Gasket
32	029631	Bearing Holder Nut
33	026423-E	64 oz. Eastman Container
34	029003-E	32-48 oz. Eastman Container
35	026798	Support Washer
36	026648	64 oz. Containter / stainless steel
37	026649	Container Support
38	026797	Bearing Holder Gasket
39	026796	Bearing Holder Washer
40	026795	SS Jar Bearing Holder Nut

Notes for 503347 & 503348 :

Torque 100-125 in/lbs

Sealant all around the threads, fill in flats.
Dow Corning Sealant RTV 733

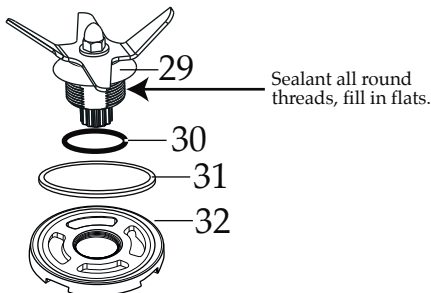

031060
Blending Assy. Kit

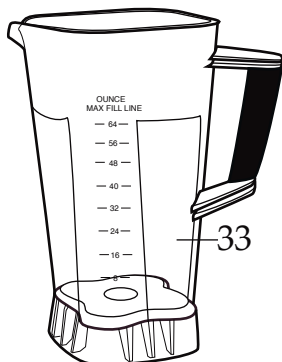
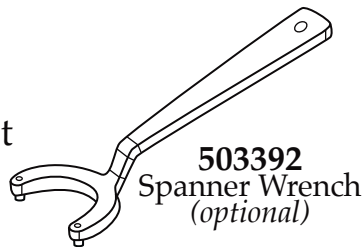

503347 and 503348 - Eastman Containers



Notes for 503346 :

Torque 100-125 in/lbs

Sealant applied all around indicated areas.
Dow Corning Sealant RTV 733

Lubricant applied to O Ring
Dow Corning 200 (R) Fluid

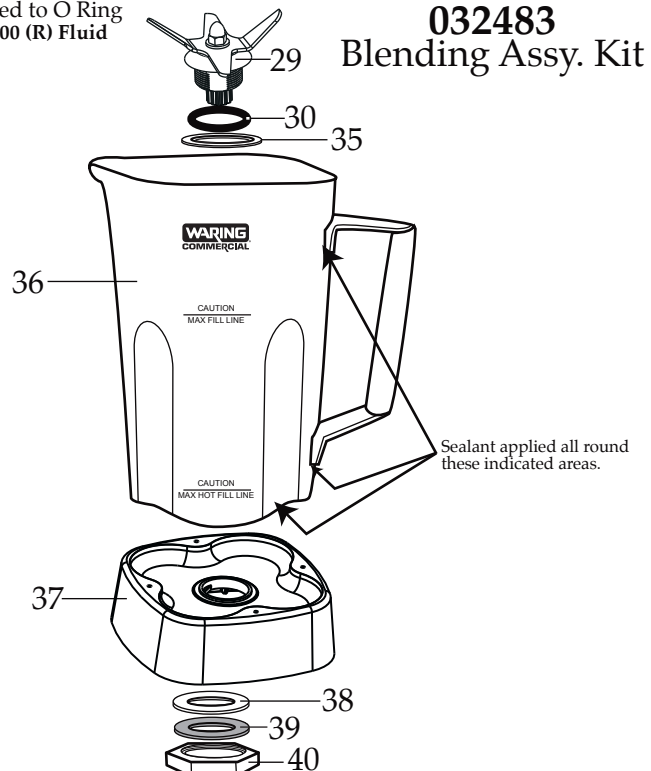

503346 - Stainless Steel Container

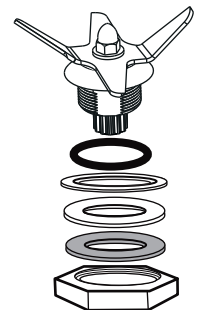

032483
Blending Assy. Kit